

CHANDLER PARLOR

UNION STAMP S.O. 1104 SCENIC DESIGNER 	AMERICAN BROADCASTING COMPANIES abc		DRAWING NO.
	PROD.: ALL MY CHILDREN STUDIO TV		OF 5
	SET: CHANDLER PARLOR		
	SCALE: 1/2"=1'-0"	DEL. DATE: 12-31-09	
	DRAWN: DATE:	PROD. DATE: 1-4-10	
DESIGNER: M. FAHNER	DRAFTSMAN: RS		

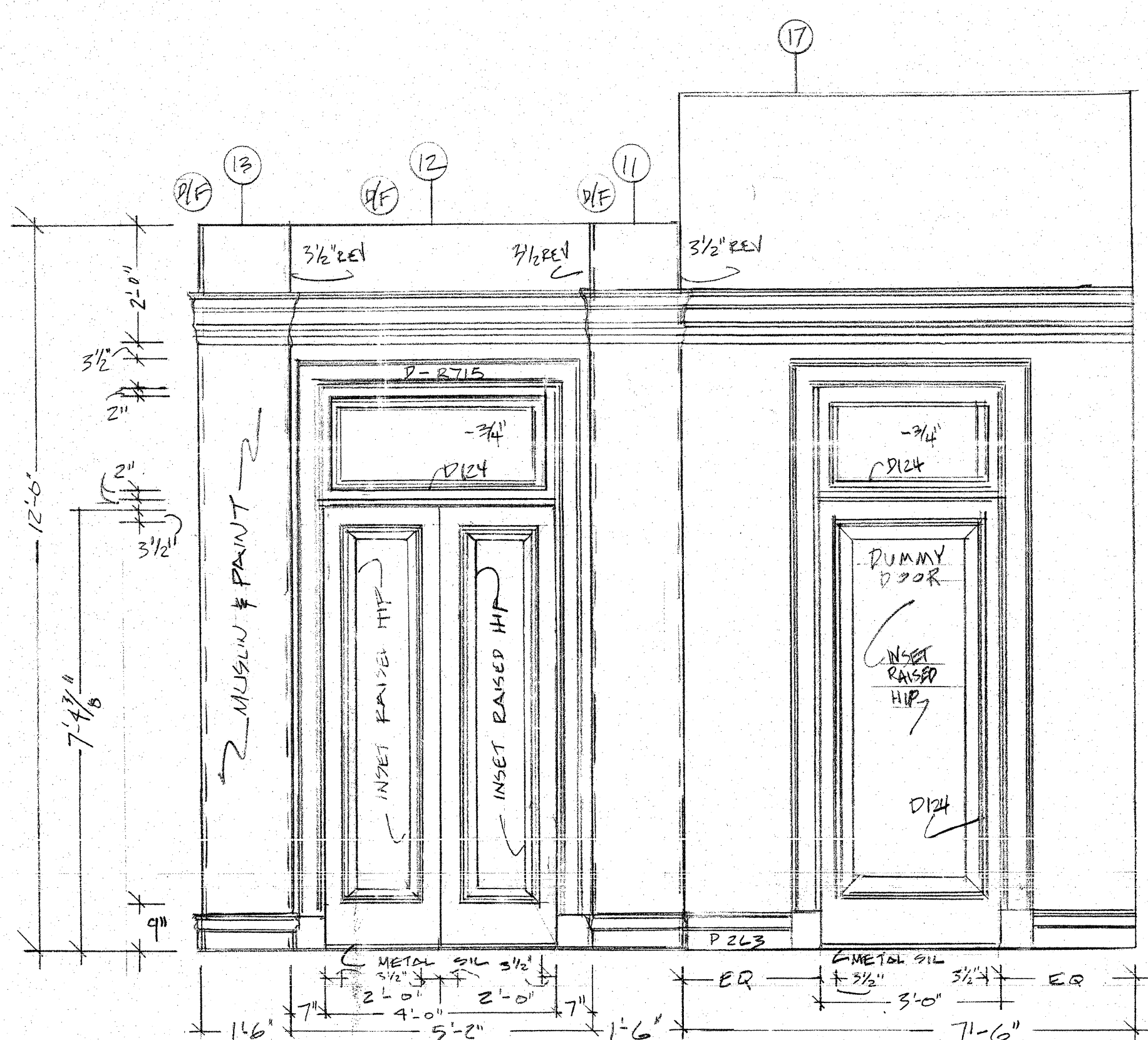

F. FRONT DOOR TO PARLOR
SCALE 1/2" = 1'-0"

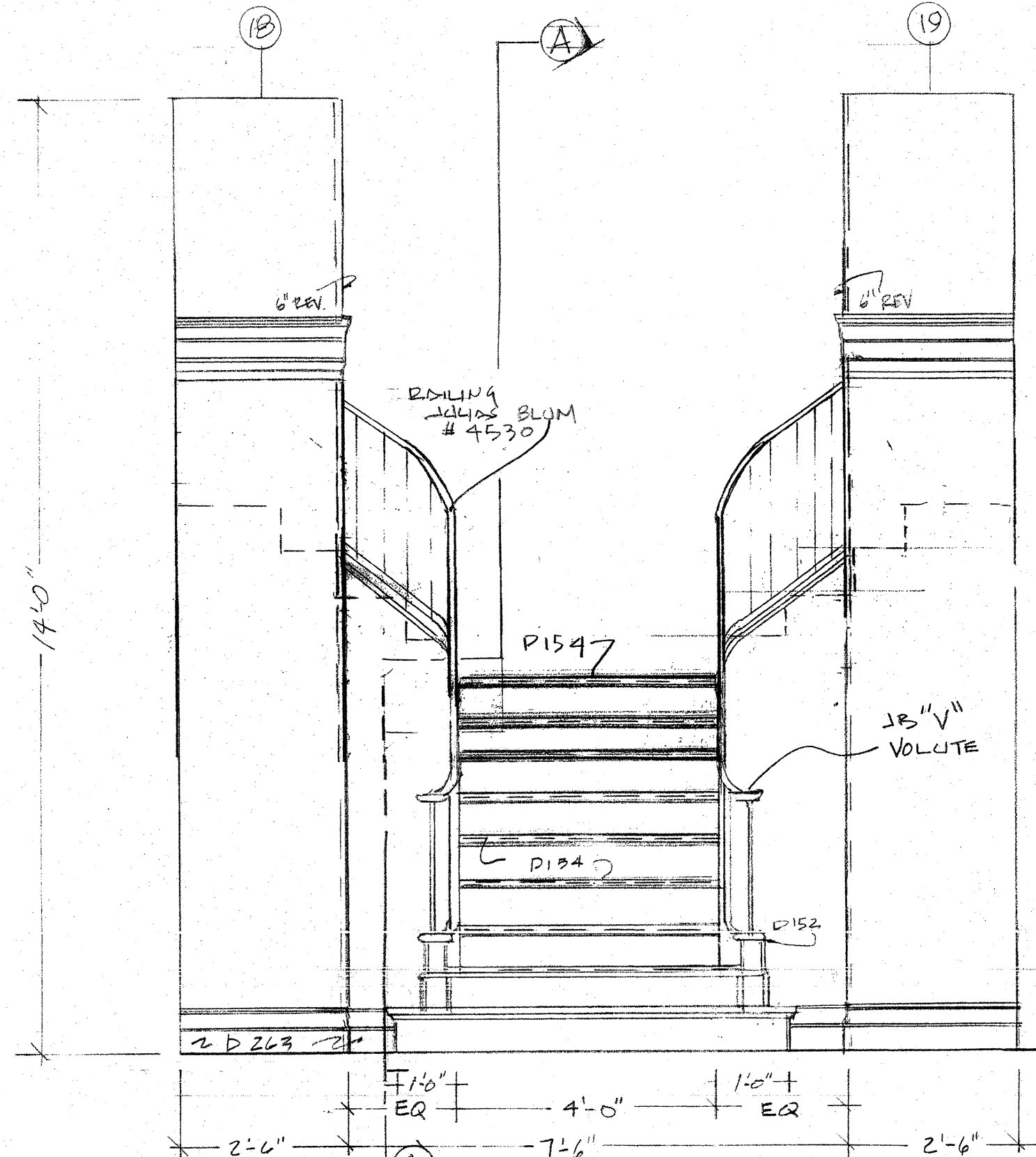
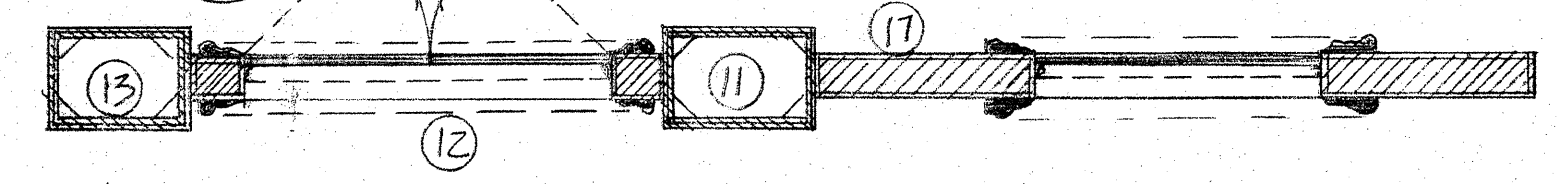

G. STAIRS
SCALE 1/2" = 1'-0"

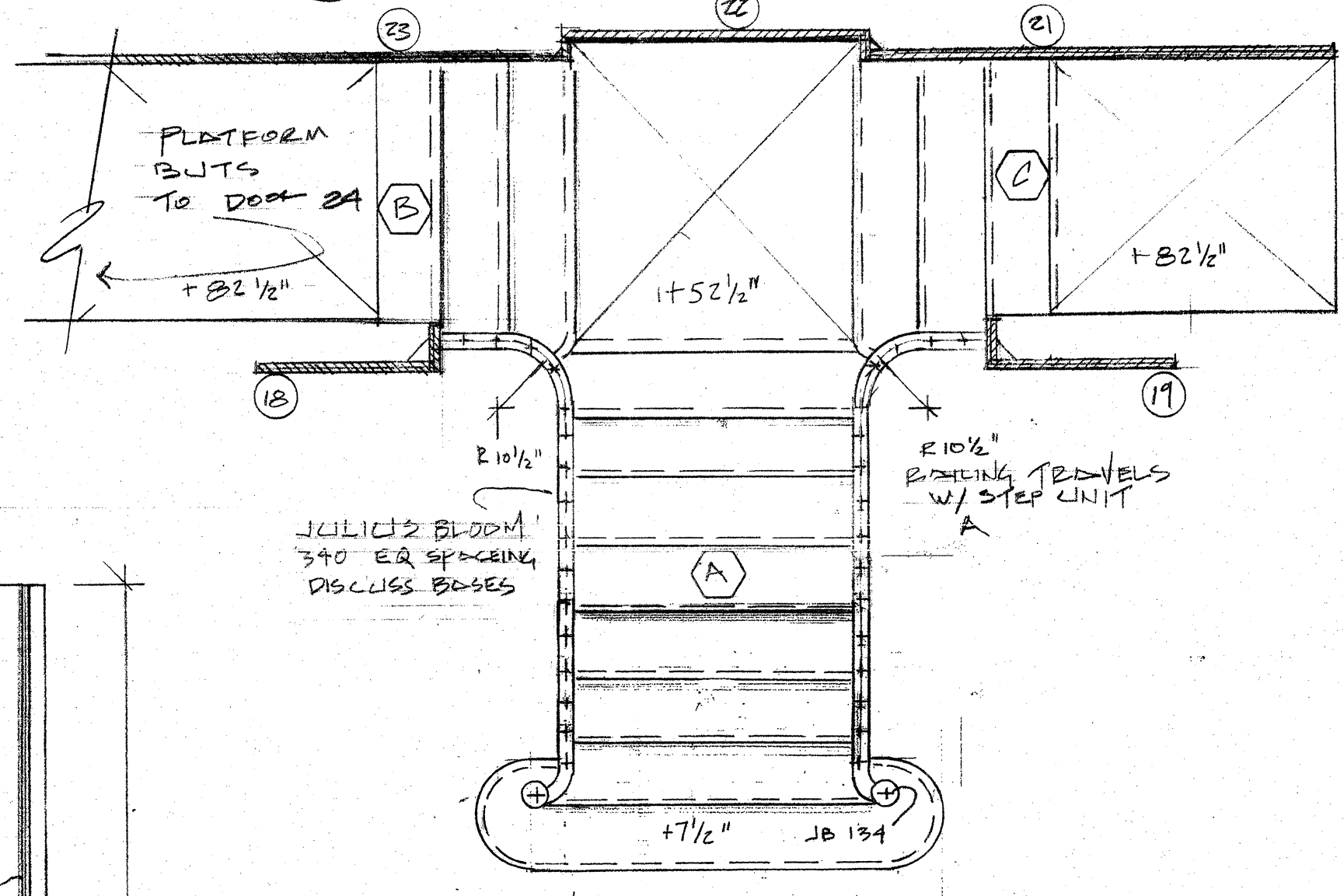

NOTE:
- USE RETRACTABLE CASTERS ON STAIRCASE SO IT CAN LOWER TO FLOOR WHEN IN PLACE.

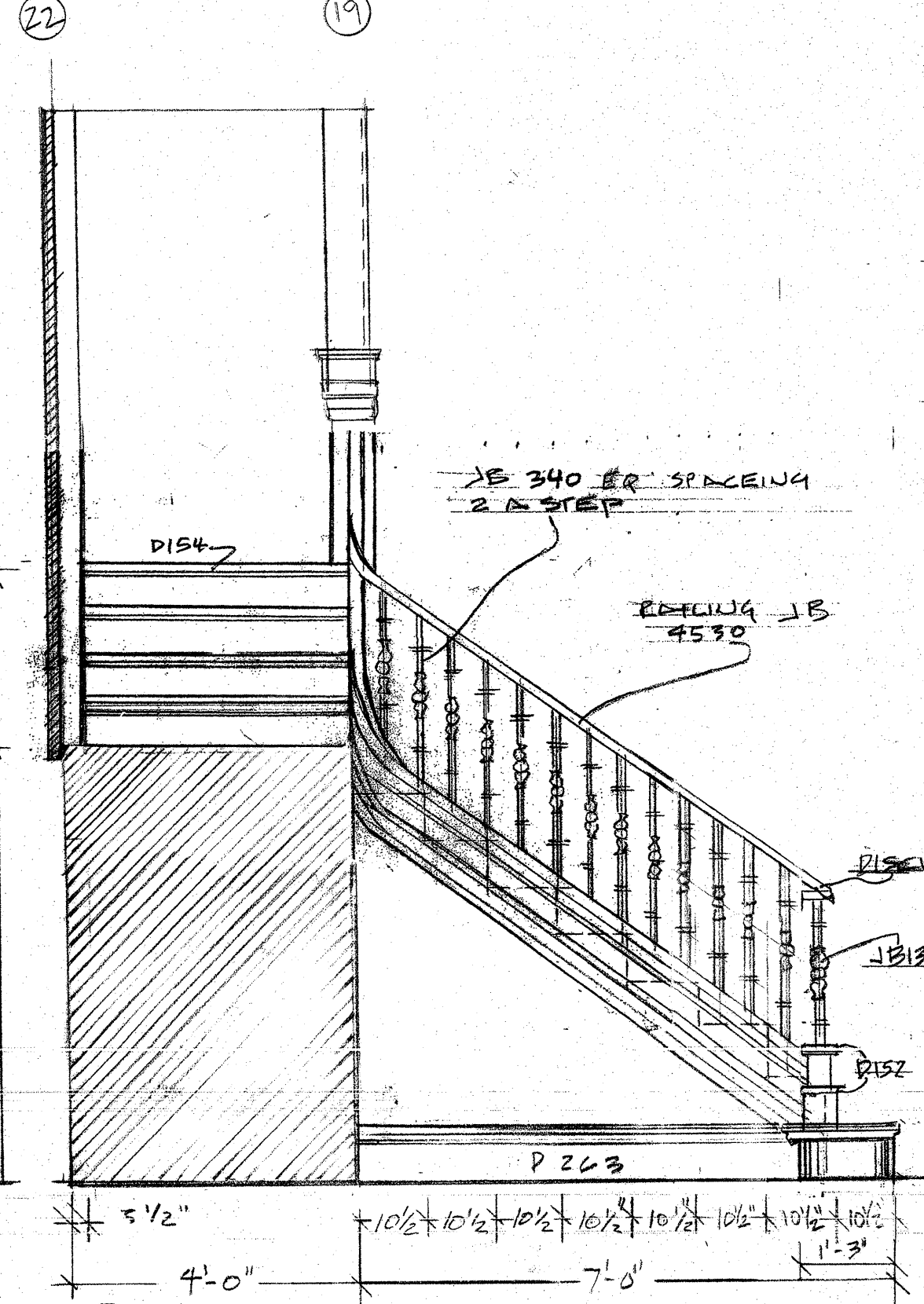

AA. STAIR SECTION
SCALE 1/2" = 1'-0"

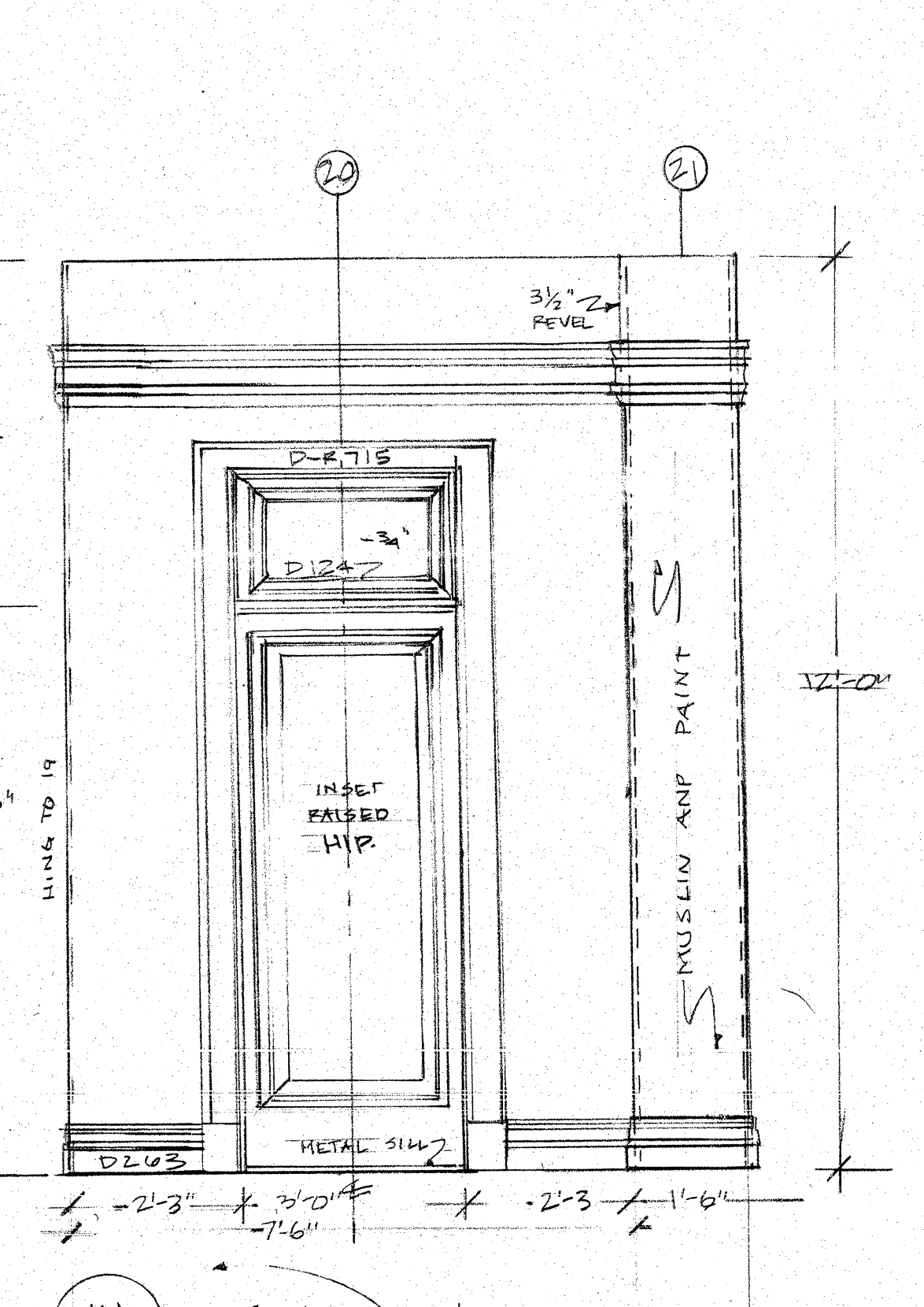

H. S. R. DOOR
SCALE 1/2" = 1'-0"

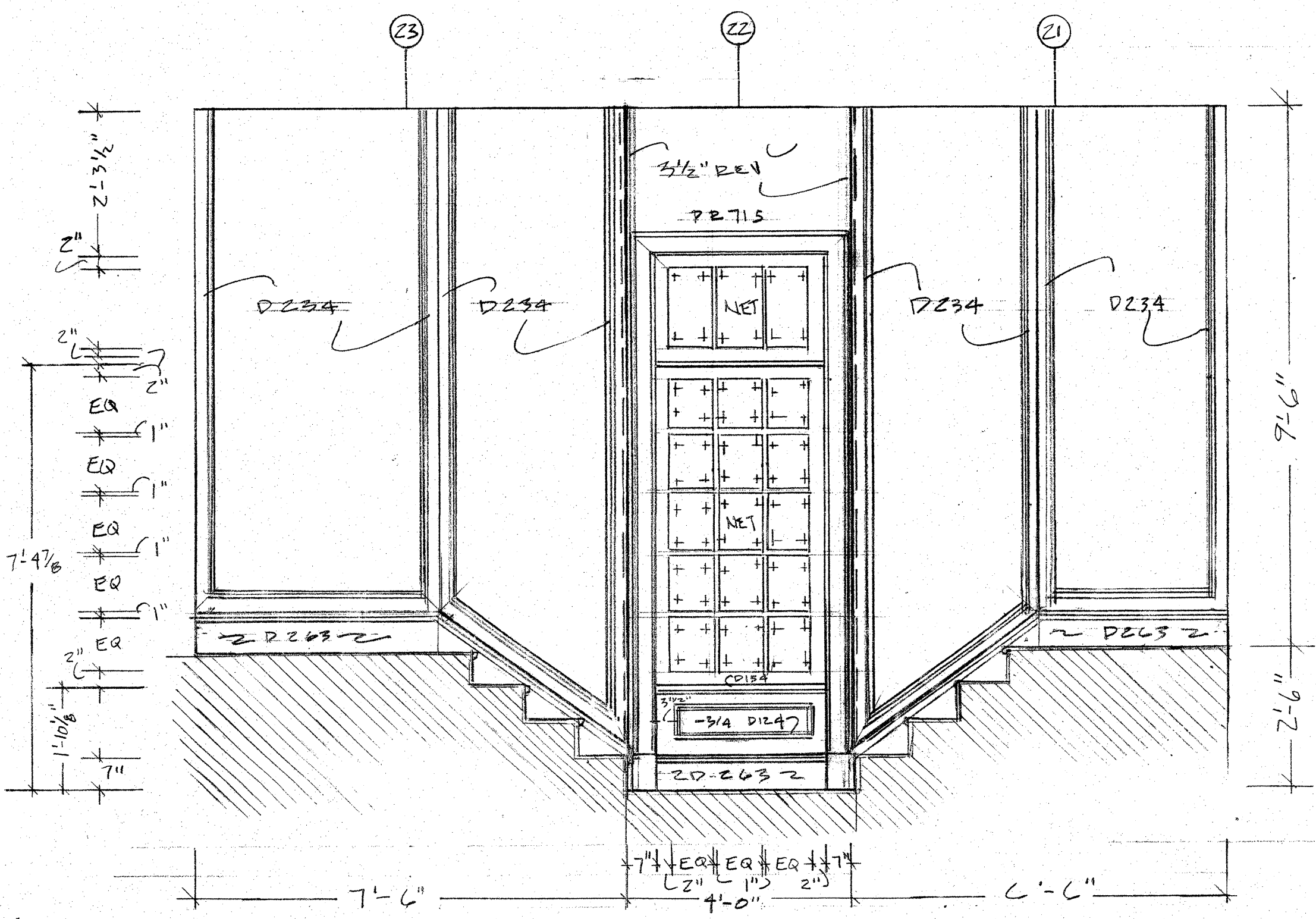
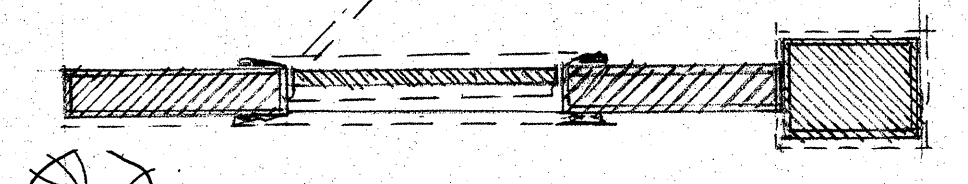

I. STAIR BACKINGS
SCALE 1/2" = 1'-0"

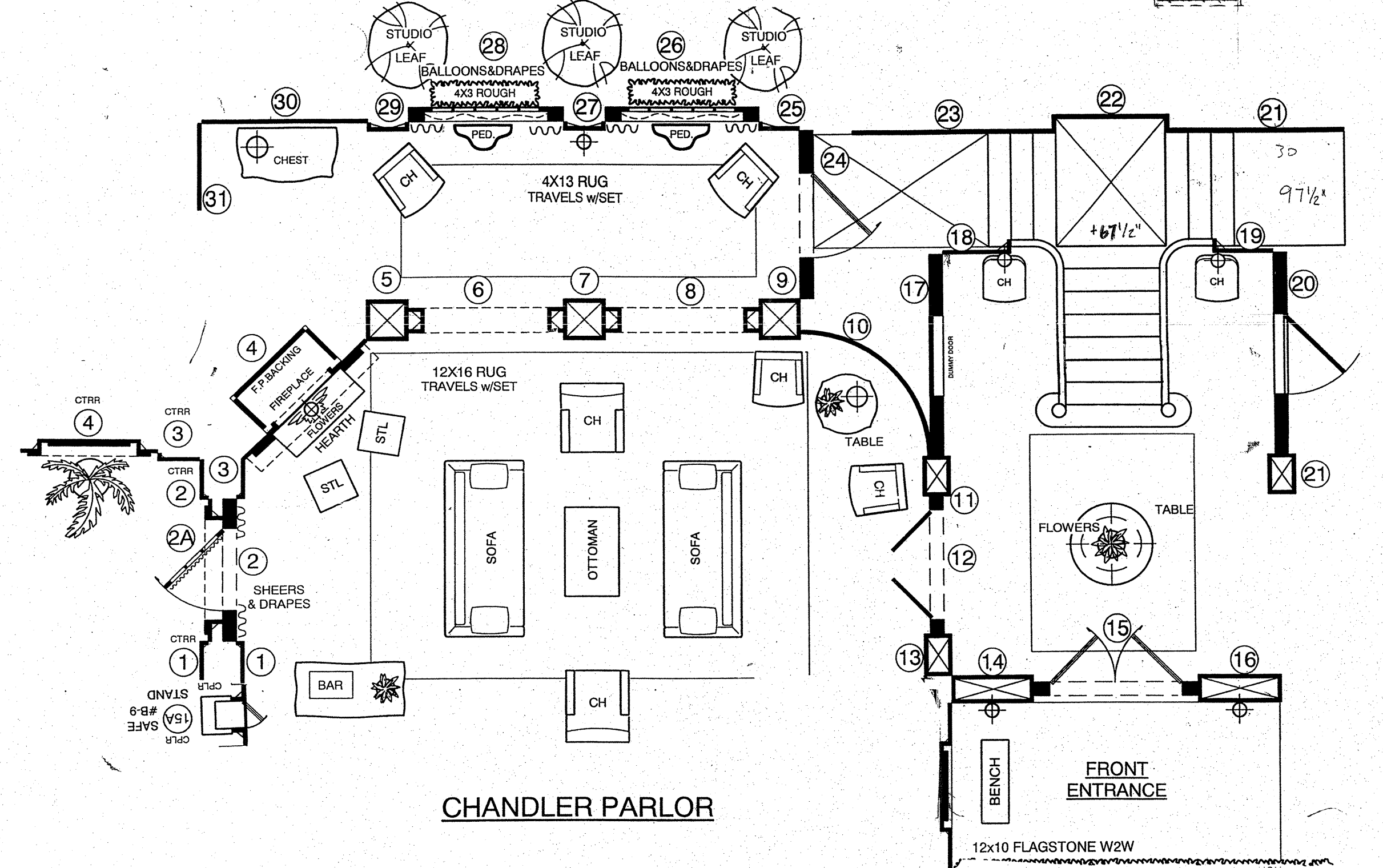

CHANDLER PARLOR

UNION STAMP S.D. 1104 SCENE DESIGNER U. FARBER	AMERICAN BROADCASTING COMPANIES abc		DRAWING NO. 2
	PROD: ALL MY CHILDREN STUDIO TV		OF 5
	SET: CHANDLER PARLOR		
	SCALE: 1/2" = 1'-0"	DEL. DATE: 12-31-09	
	DATE: 10-14-09	PROD. DATE: 1-4-10	
DESIGNER: U. FARBER		DRAFTSMAN: RS	

REVISED
10-29-09

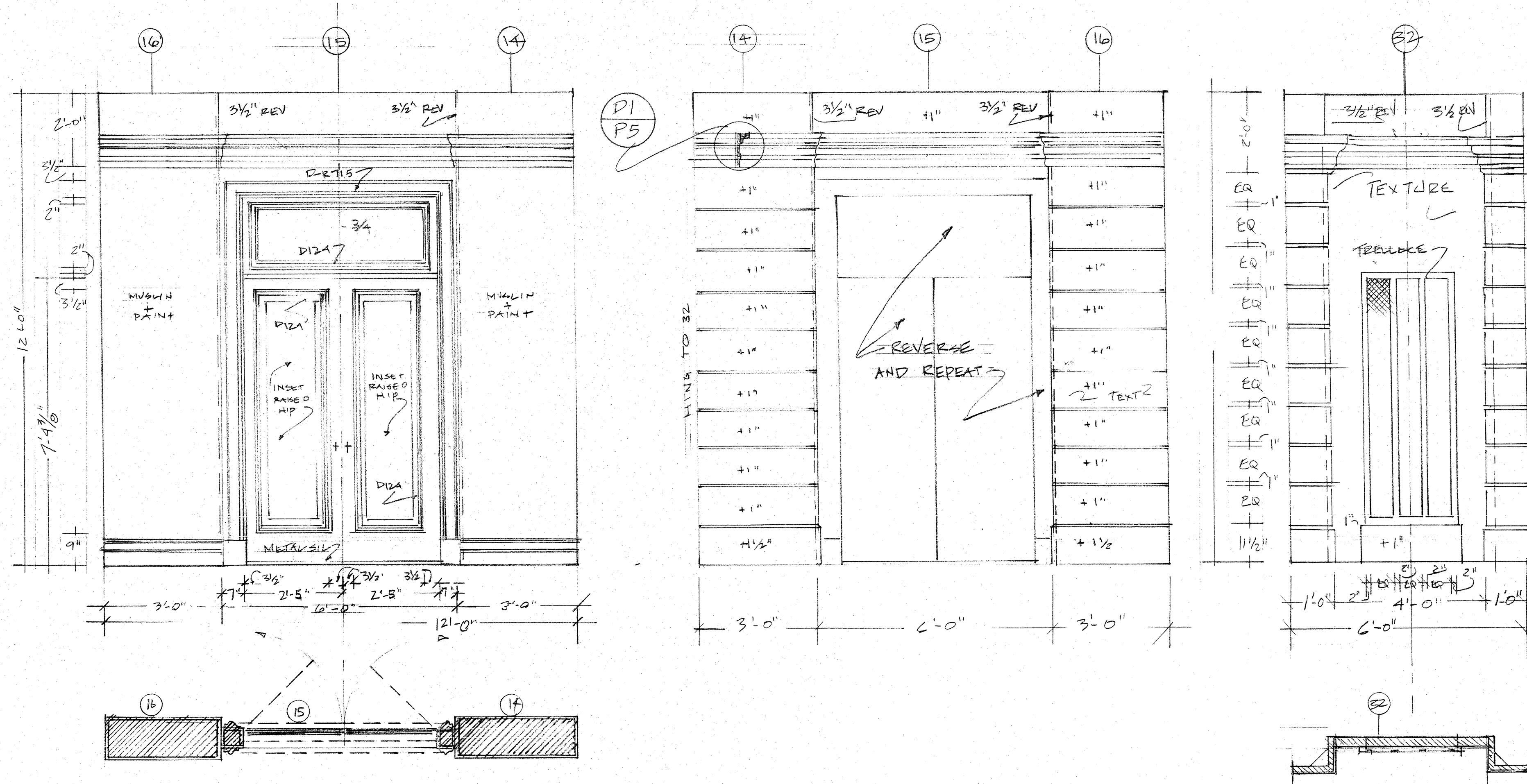

ENTRANCE DOORWAY
SCALE 1/2" = 1'-0"

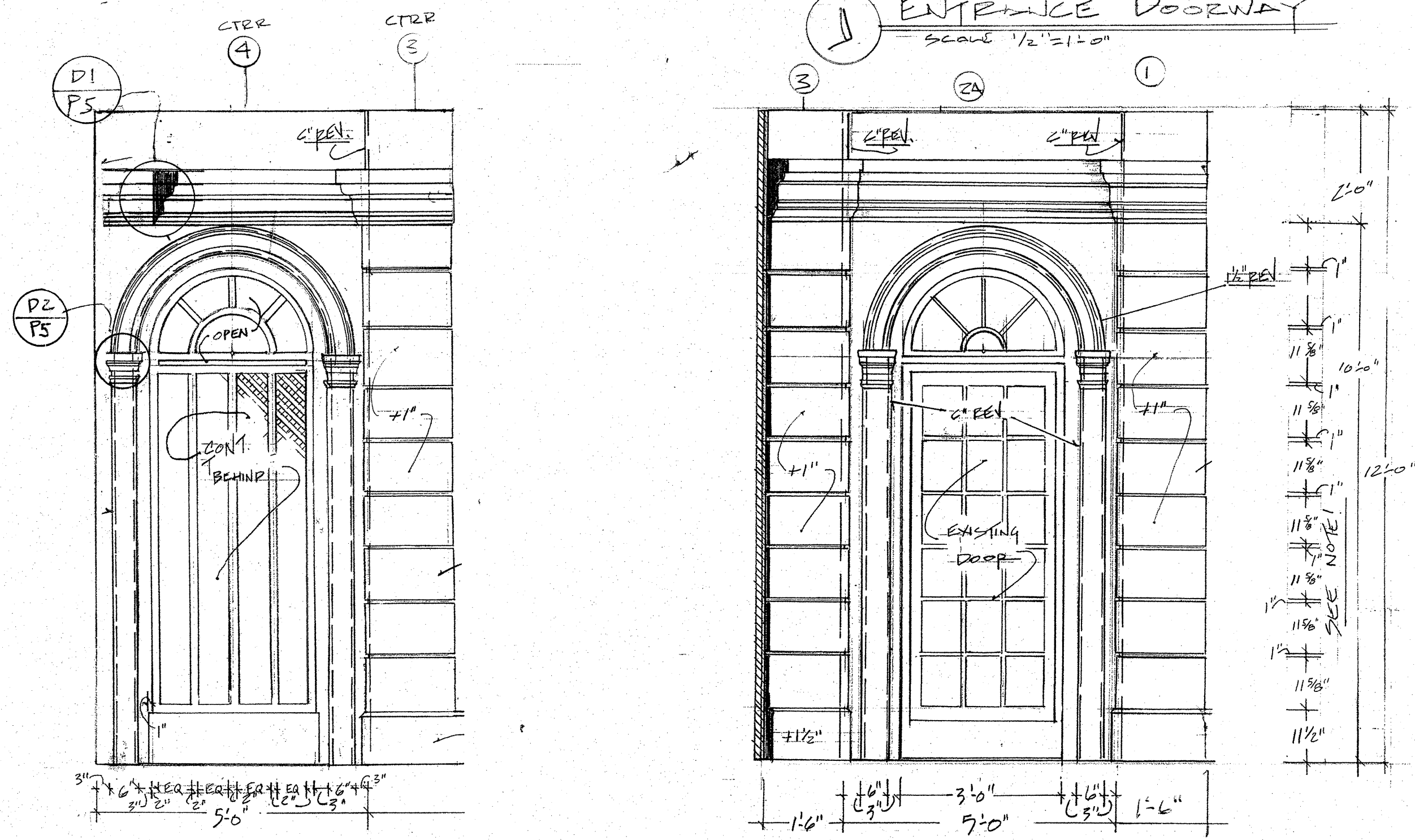

TERRACE WINGS - LABEL "CHANDLER TERRACE"

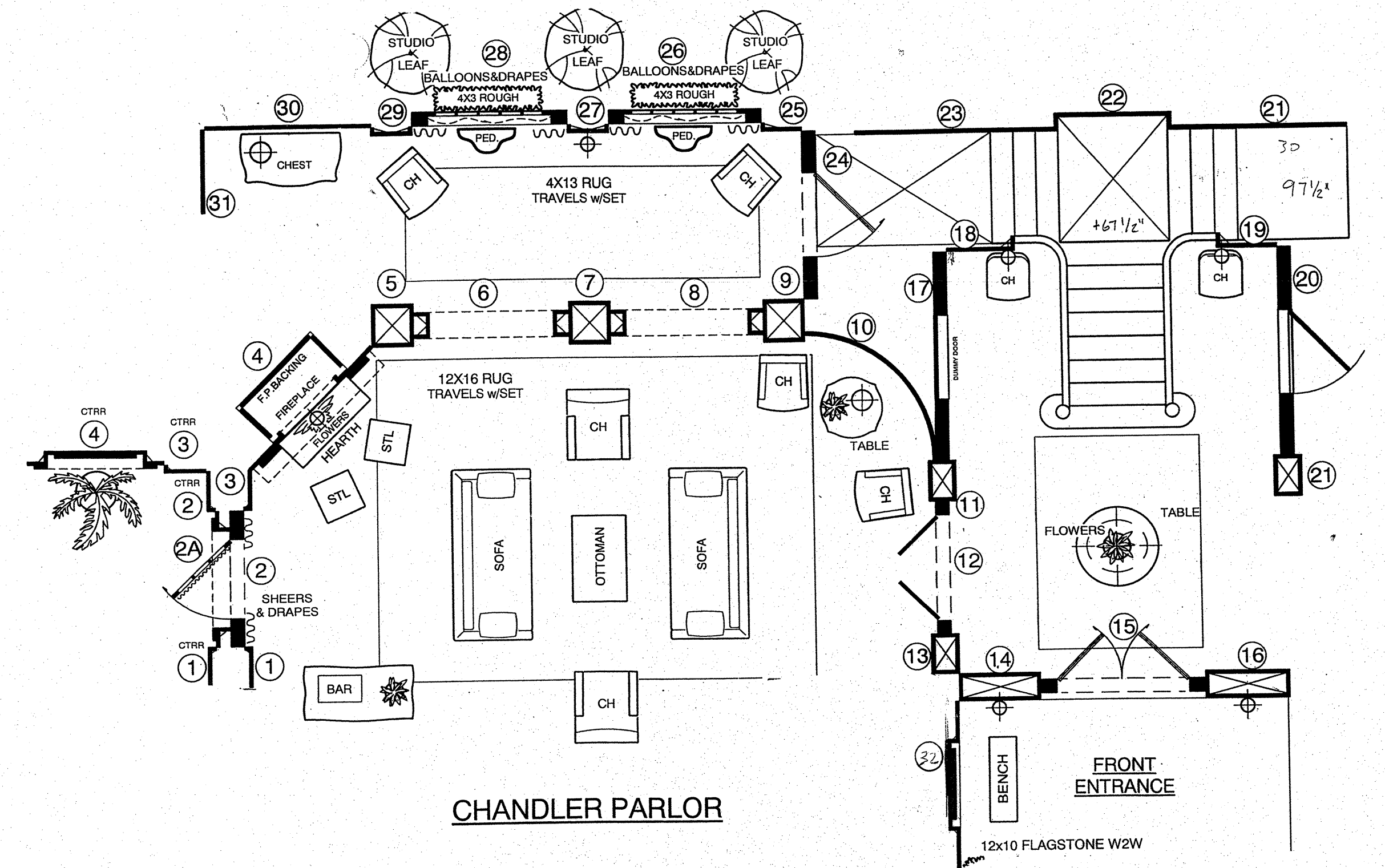

UNION STAMP S.D. 1104 SCENE DESIGNER	AMERICAN BROADCASTING COMPANIES abc		DRAWING NO.	
	PROD.: ALL MY CHILDREN STUDIO TV		3 OF 5	
	SET: CHANDLER PARLOR			
	SCALE: 1/4" = 1'-0"	DEL. DATE: 12-31-59		
	DRAWN: DATE: 10-14-59	PROD. DATE: 1-4-10		
DESIGNER: M. FOLLEN	DRAFTSMAN: C.P.			

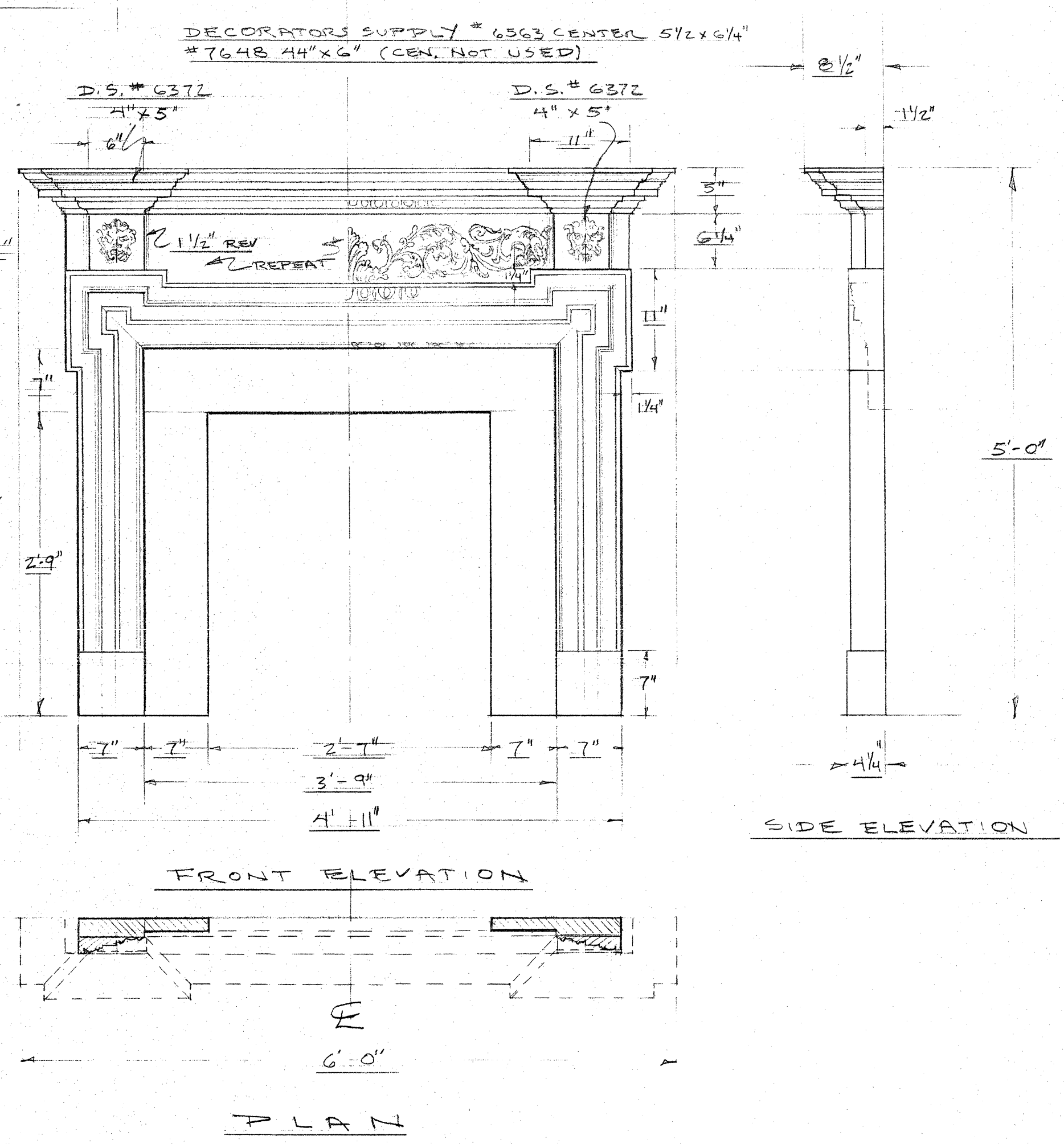
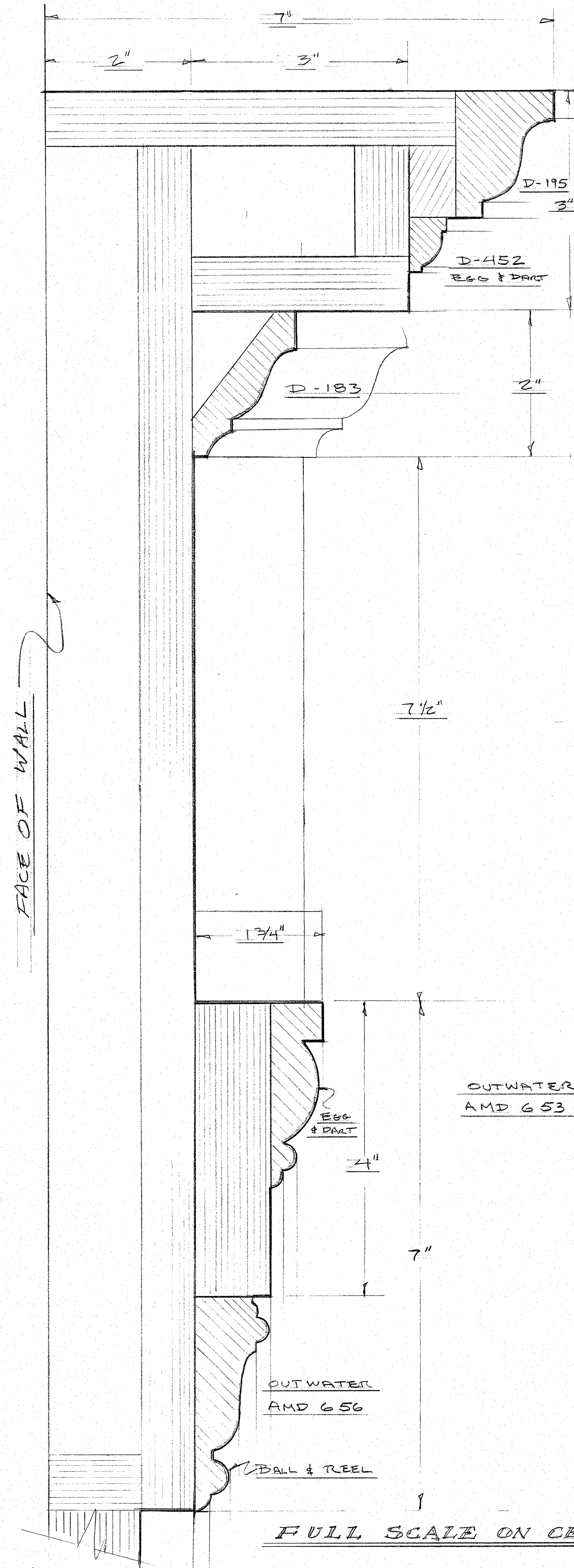

D1 FIREPLACE + MANTEL
SCALE: 1" = 1'-0"
DETAIL # 1

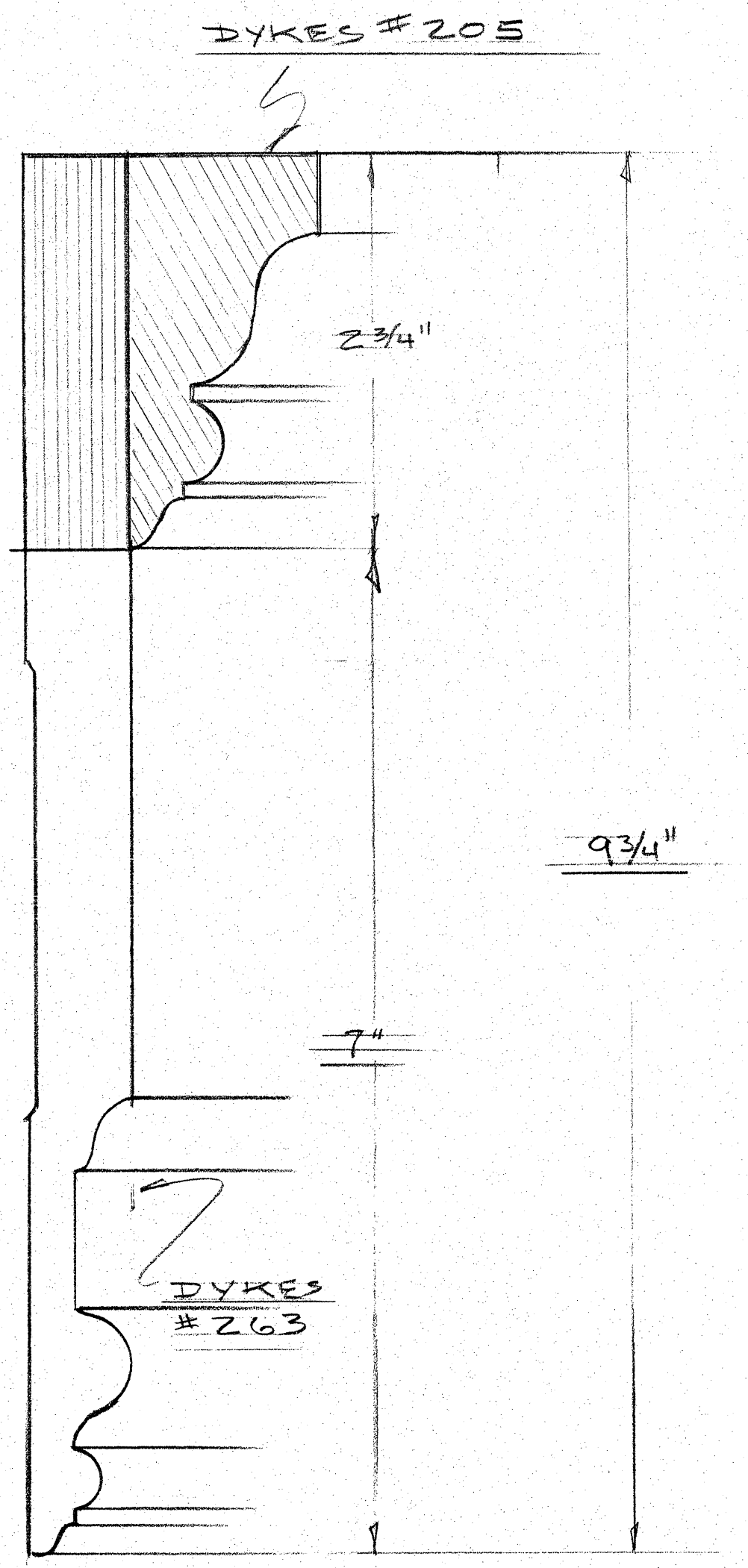

D2 CORNICE
FULL SCALE DETAIL
DETAIL # 2

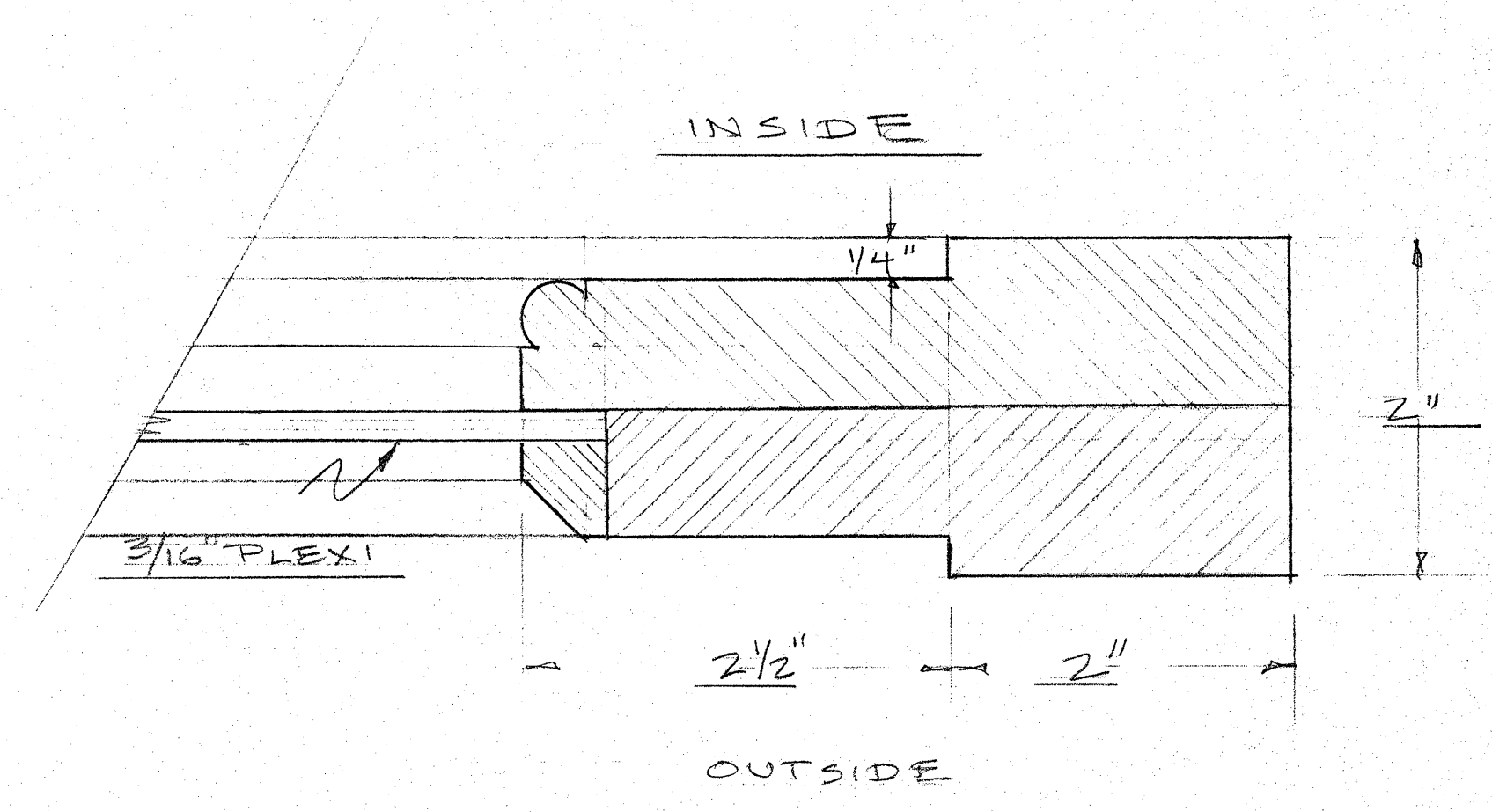

D3 DETAIL # 3
FULL SCALE OF DOORS

REVISION
4-13-09

UNION STAMP S.D. 104 SCENIC DESIGNER <i>[Signature]</i>	AMERICAN BROADCASTING COMPANIES abc		DRAWING NO.
	PROD: ALL MY CHILDREN	STUDIO TV	4
	SET: CHANDLER PARLOR		
	SCALE: VARIOUS	DEL. DATE: 12-31-09	OF 5
	DRAWN: 10-19-09	PROD. DATE: 1-4-10	
DESIGNER: M. FALKER	DRAFTSMAN: J. MICHAEL DEEGAN		

