

A DSR WALLS
SCALE 1/2" = 1'-0"

B USE WALLS
SCALE 1/2" = 1'-0"

C C.S. ALCOVE

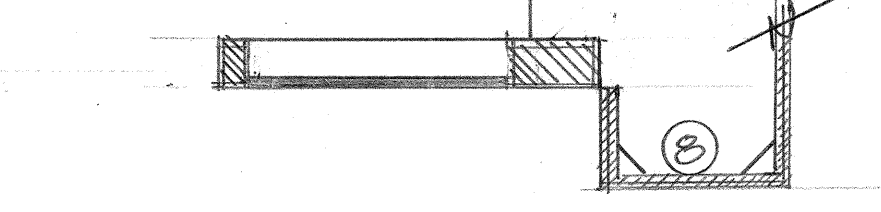
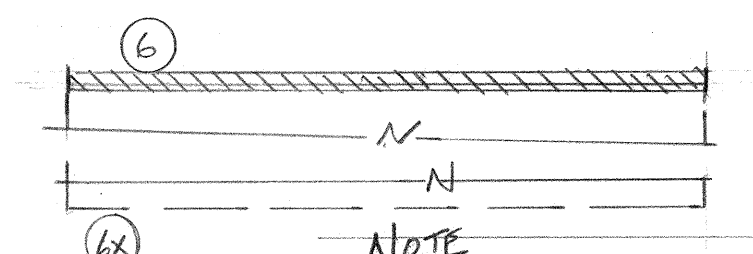
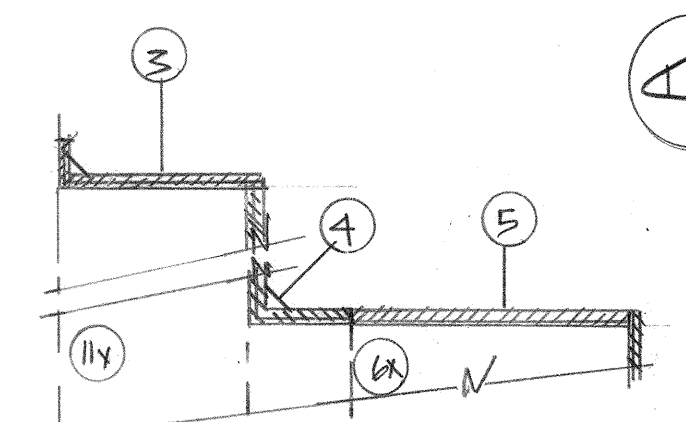
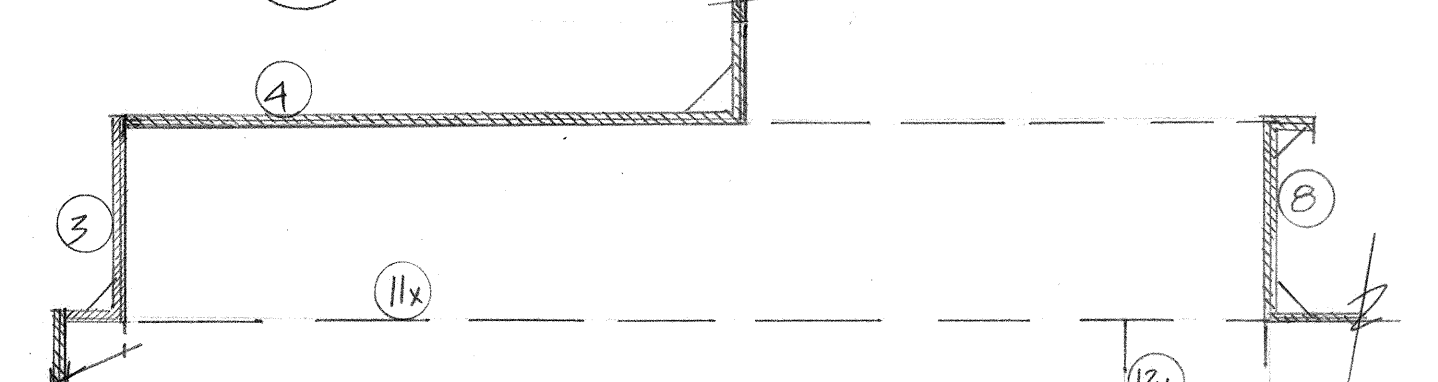
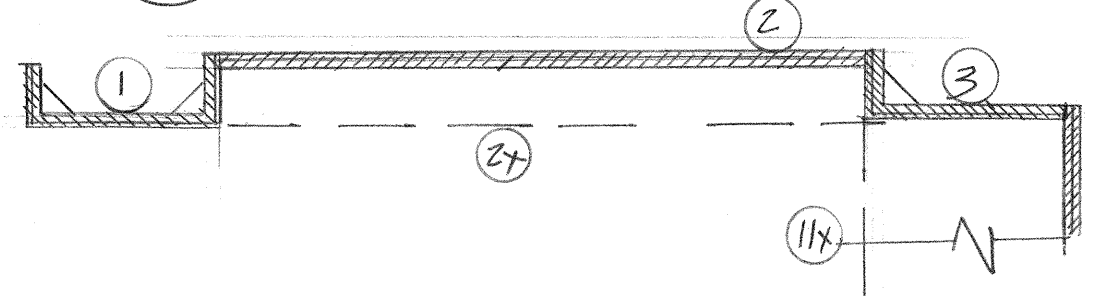

NOTE
- TREADS WILL BE
BROKEN & DISTRESSED
PER DESIGNER

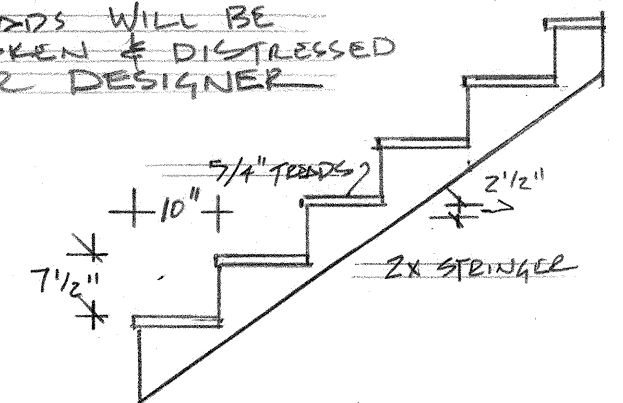
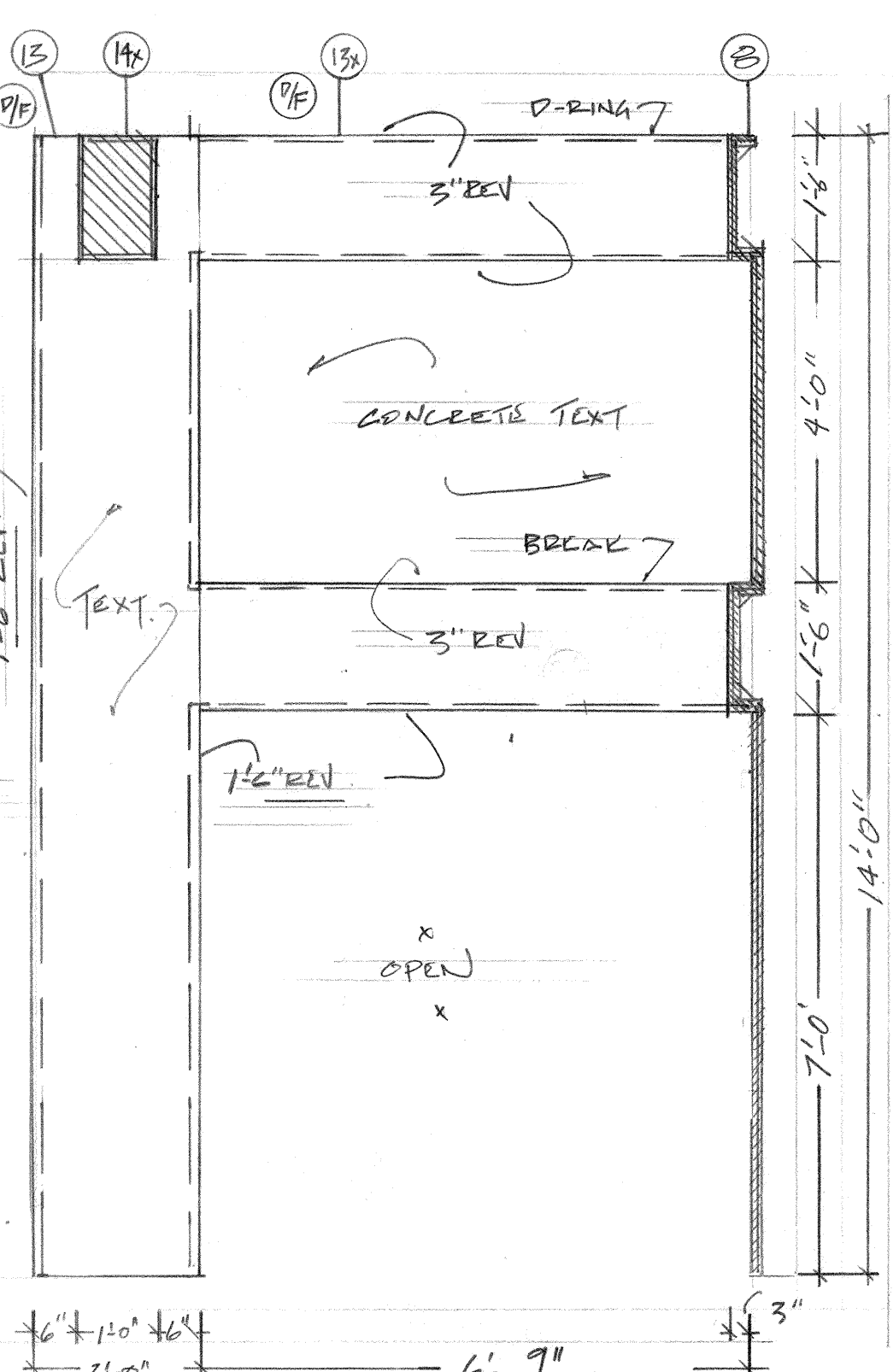
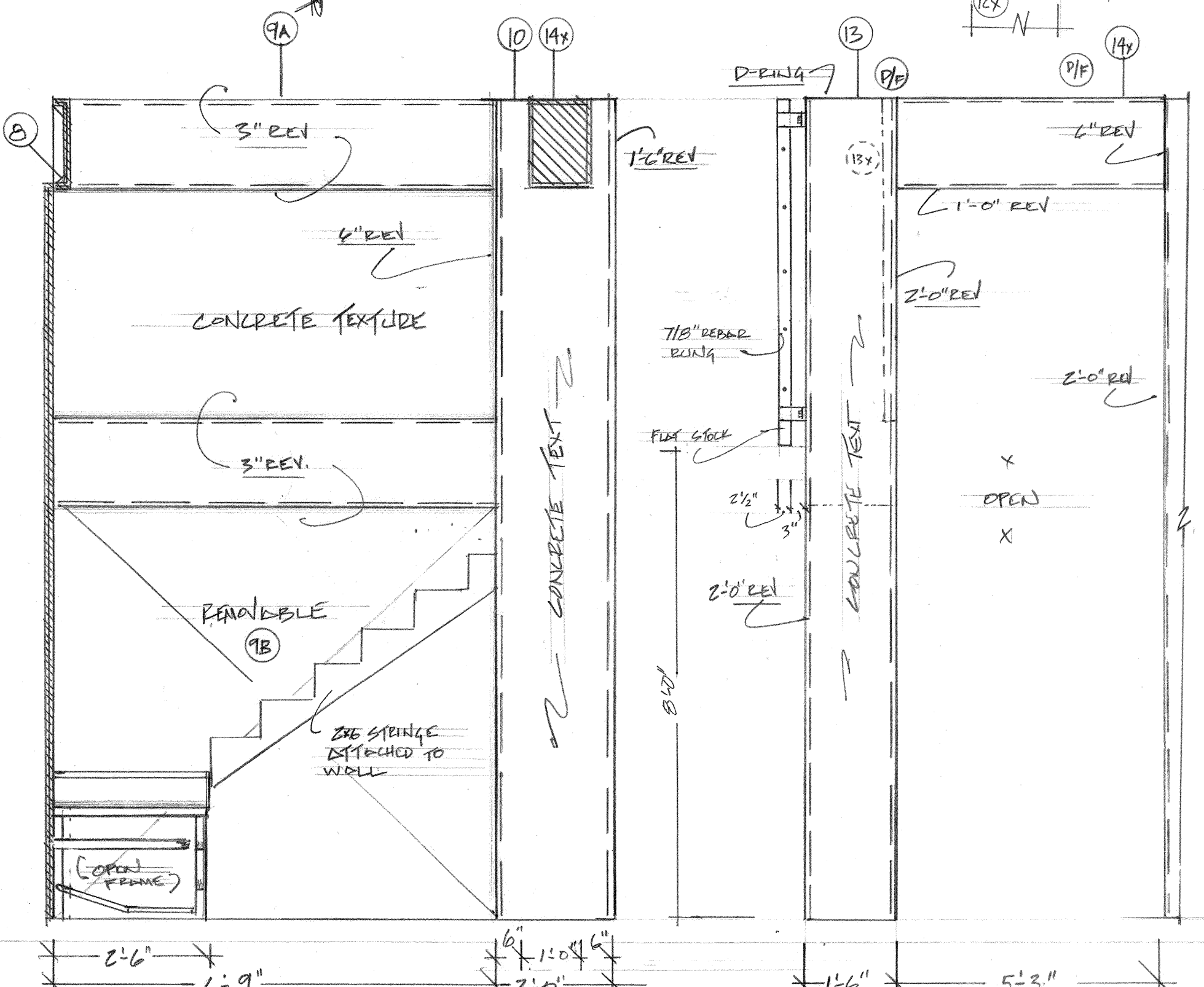
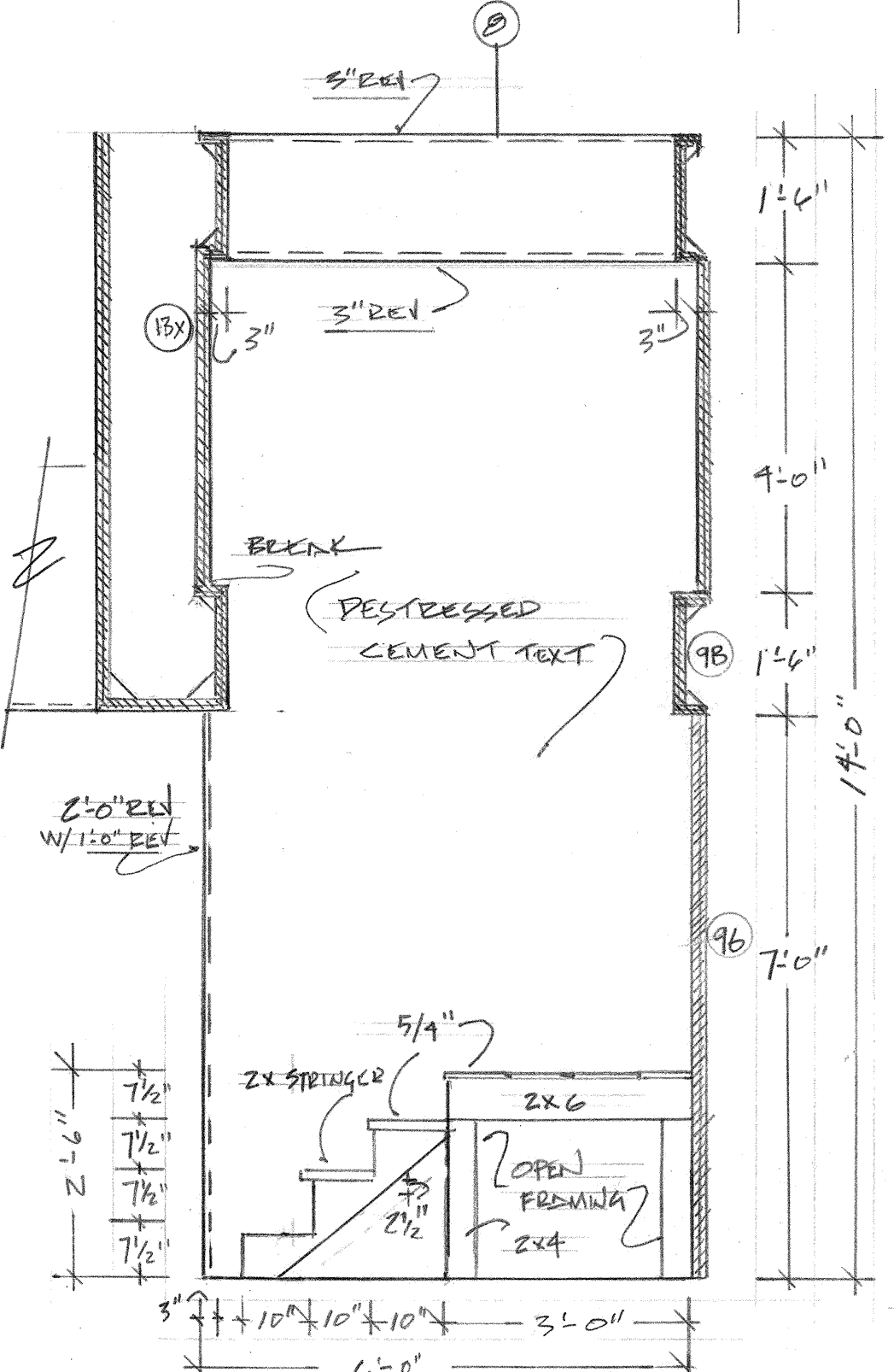

H BROKEN STEPS
SCALE 1/2" = 1'-0"

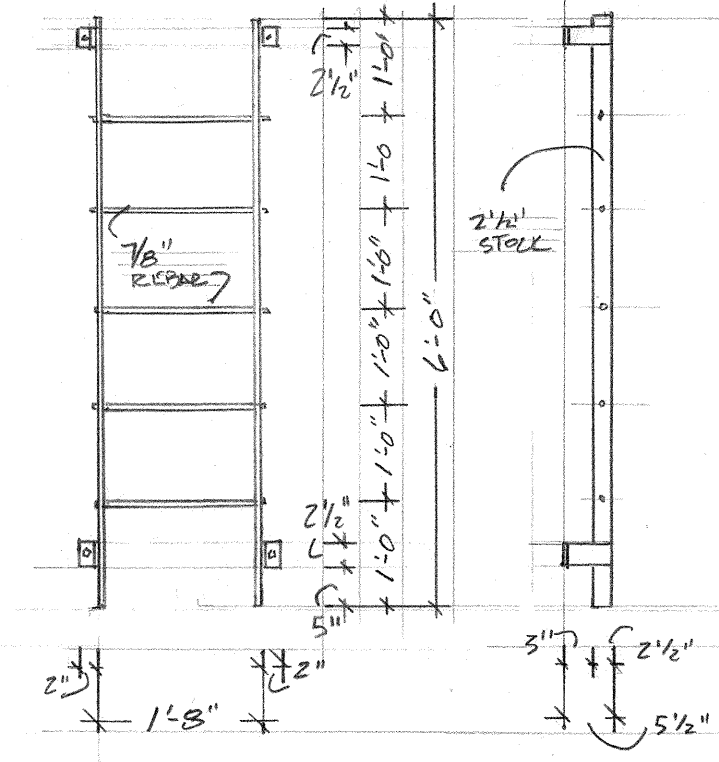

I PEBBLE LADDER
SCALE 1/2" = 1'-0"

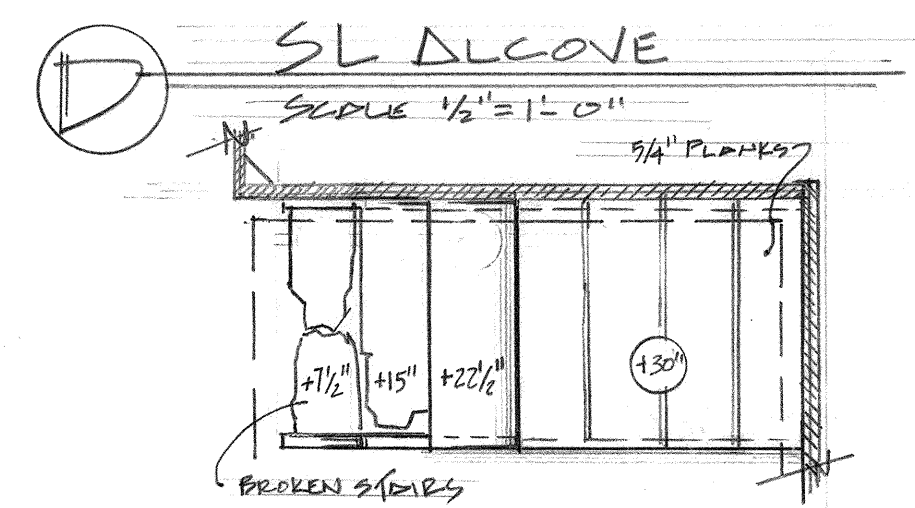

J SL ALCOVE
SCALE 1/2" = 1'-0"

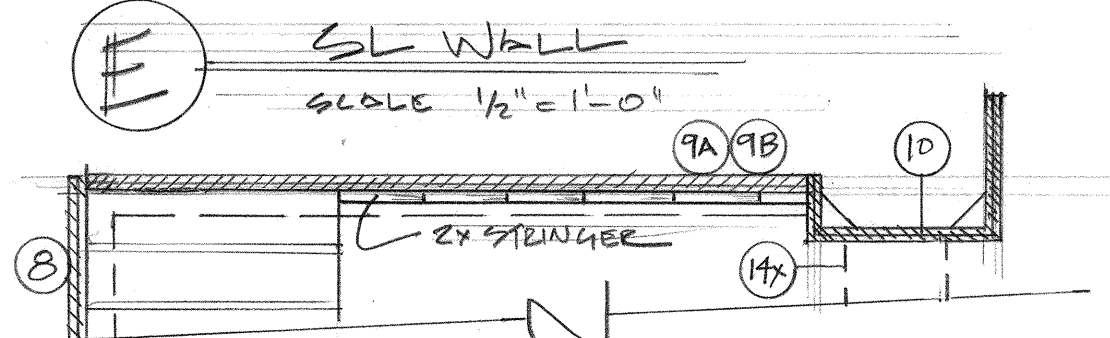

K SL WALL
SCALE 1/2" = 1'-0"

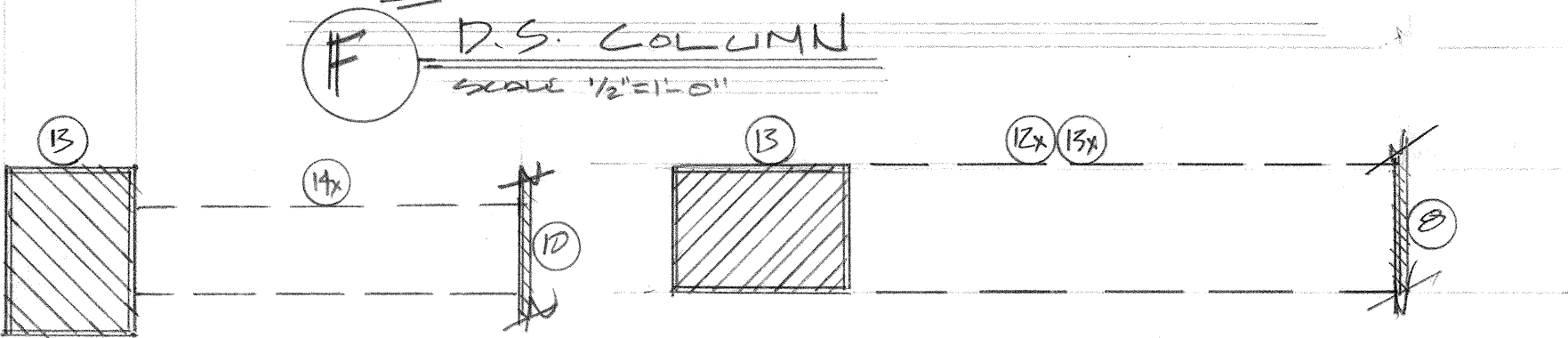

L D.S. COLUMN
SCALE 1/2" = 1'-0"

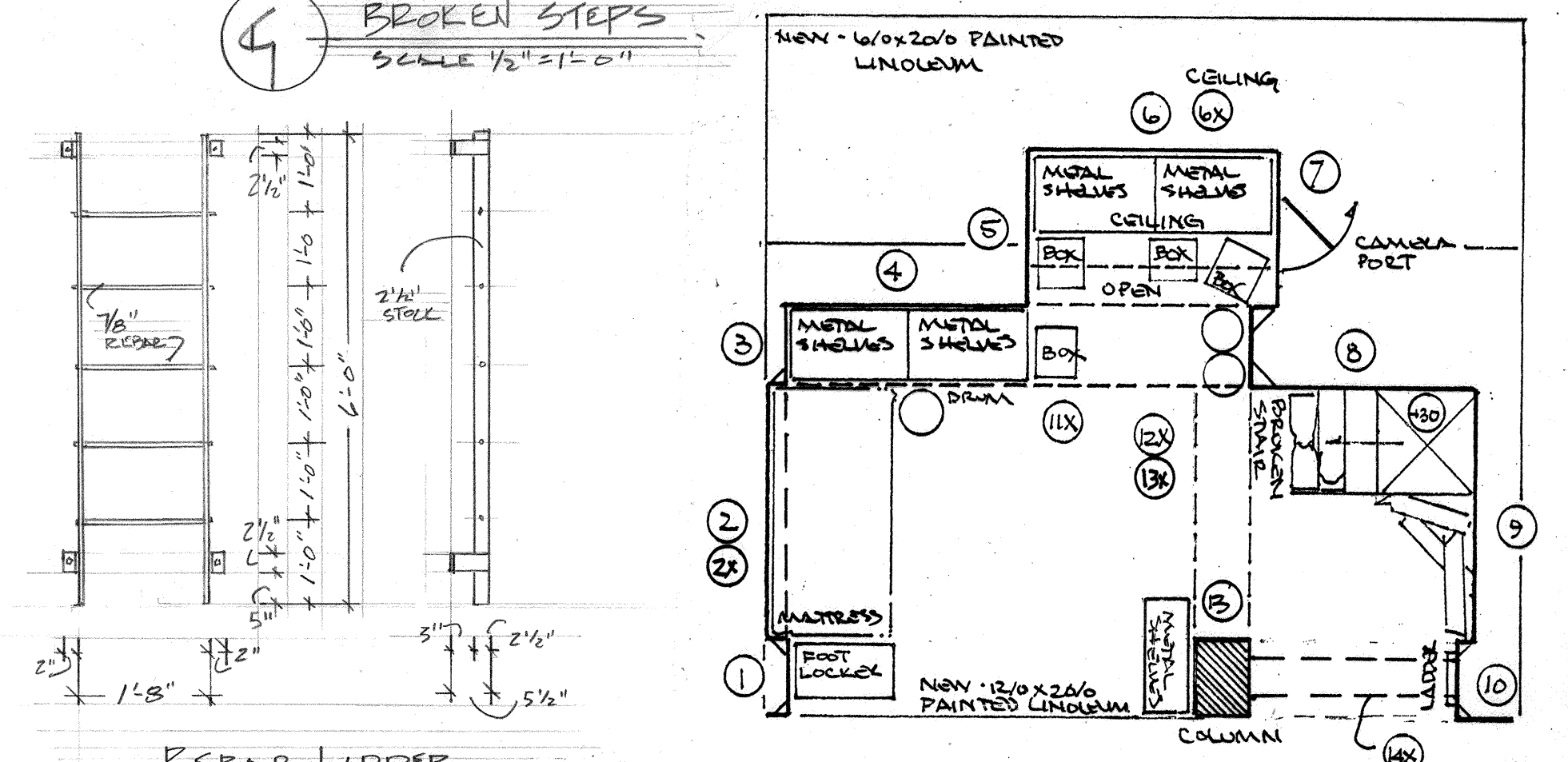

M BOMB SHELTER

UNION STAMP	AMERICAN BROADCASTING COMPANIES abc		DRAWING NO.
	PROD: ALL MY CHILDREN STUDIO 23		1 OF 1
	SET: BOMB SHELTER		
	SCALE: 1/2" = 1'-0"	DEL DATE: 10-15-07	
	DRAWN: 10-5-07	PROD. DATE: 10-16-07	
	DESIGNER: MOONEY	DRAFTSMAN: FAHBER	

10-8-07

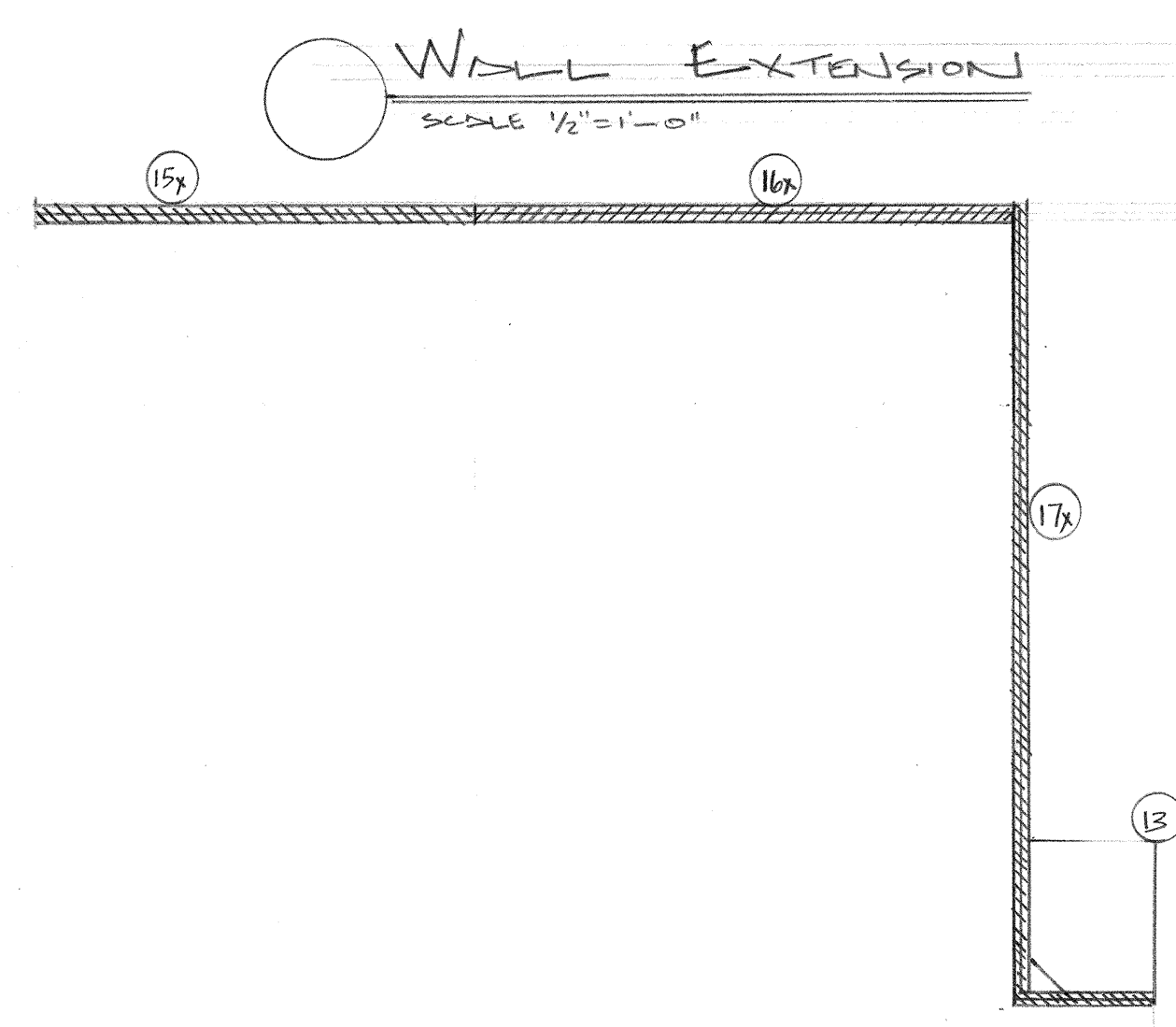
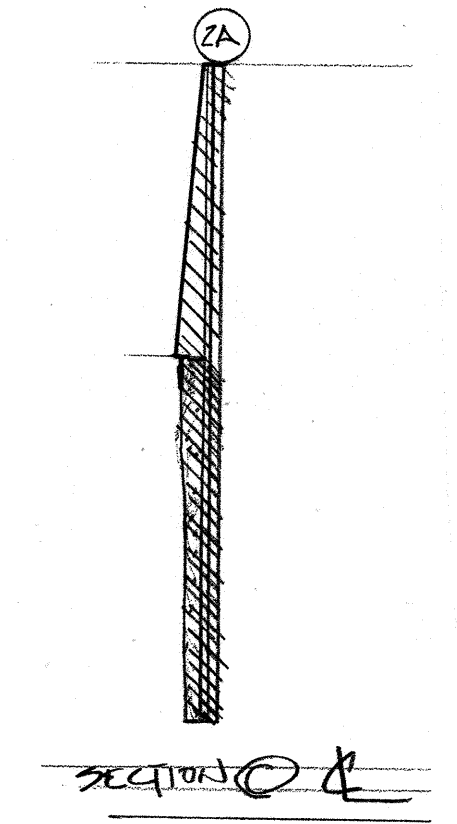
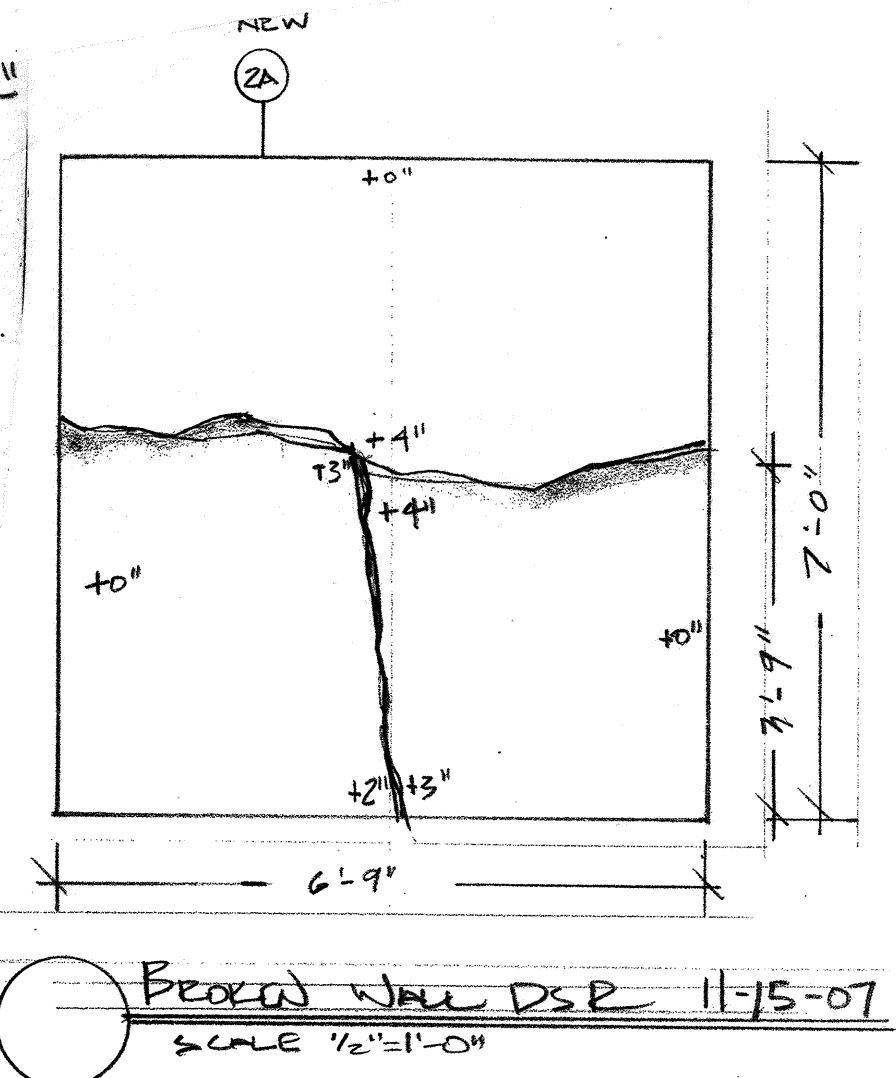
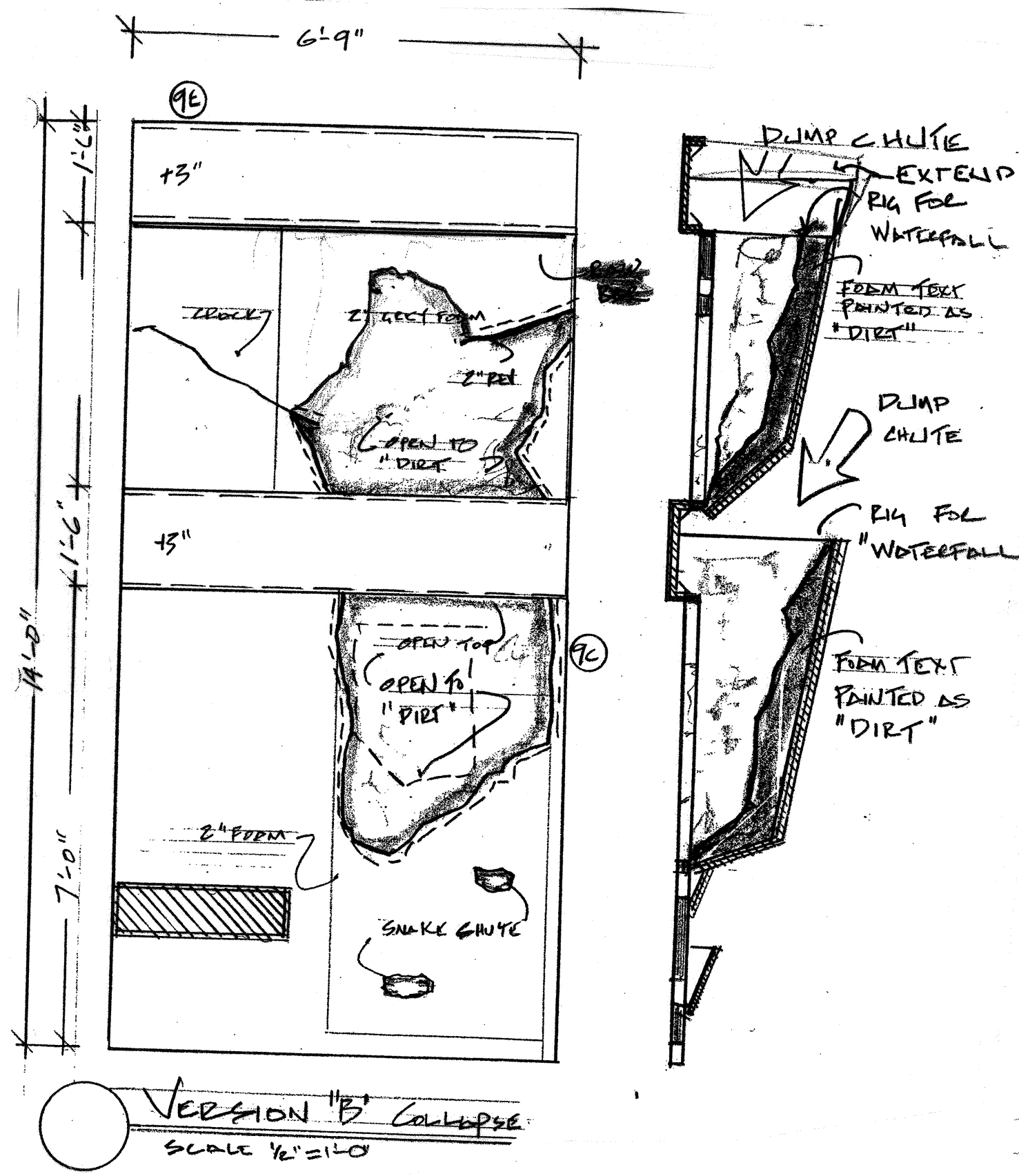
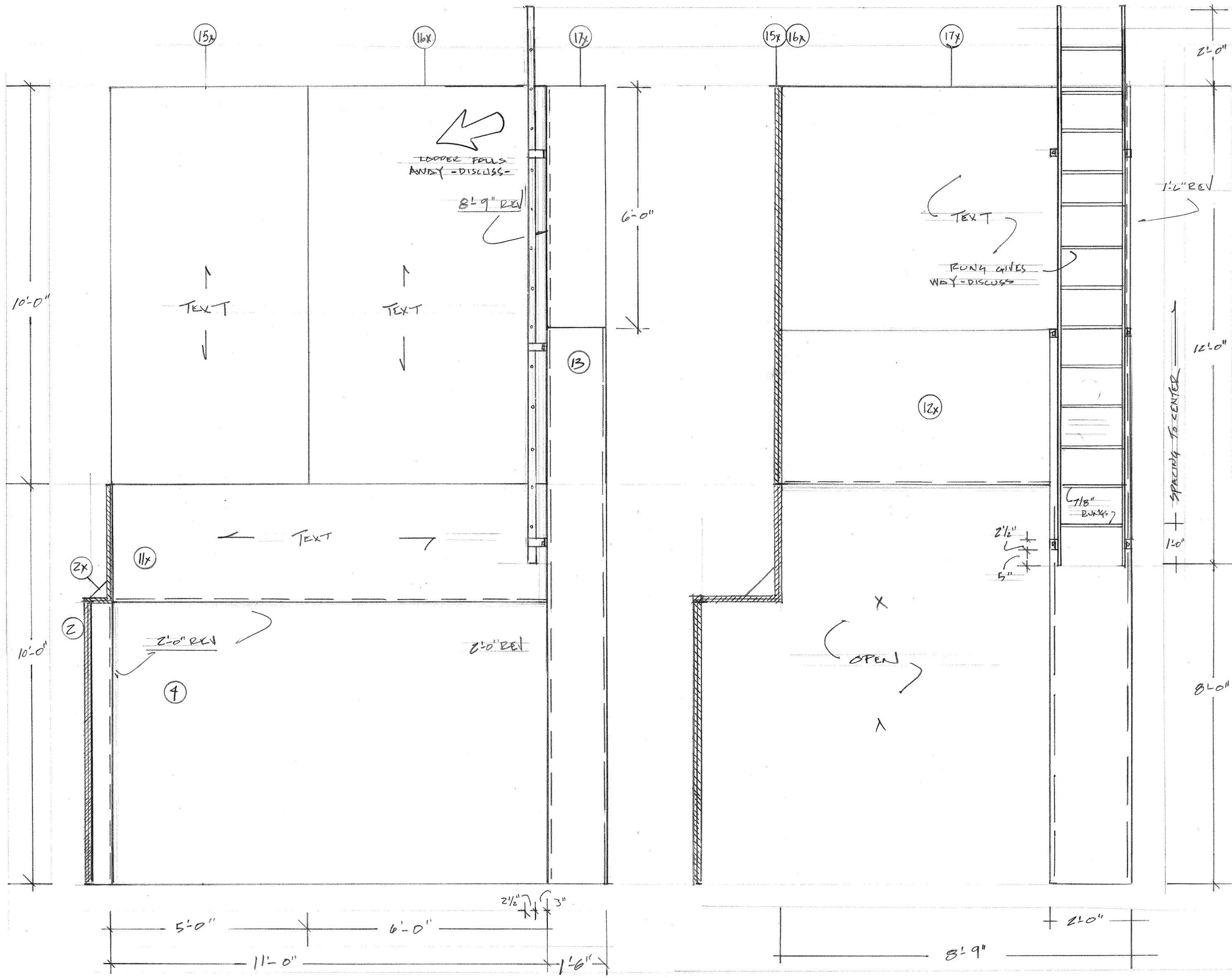

- Note:
- Ladder has special rigging that needs to be worked out ahead of time in the shop
 - Ladder rigged to fall away from wall, discuss angle and how far ladder falls from wall
 - Discuss wrung and how to rig rung falling/ bending from ladder on cue.

UNION STAMP	AMERICAN BROADCASTING COMPANIES abc		DRAWING NO.
	PROD: ALL MY CHILDREN	STUDIO TV 17	2
	SET: BOMB SHELTER		
	SCALE: 1/2"=1'-0"	DEL. DATE: 10-24-07	OF 2
	DRAWN: DATE: 10-15-07	PROD. DATE: 10-25-07	
DESIGNER: E. MOONEY		DRAFTSMAN: M. FAHLER	